

MALE

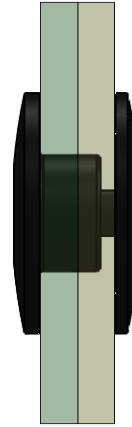

ASSEMBLY

FEMALE

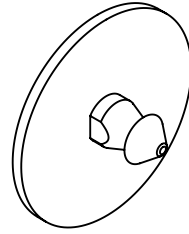
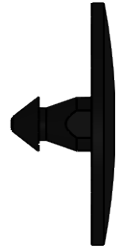
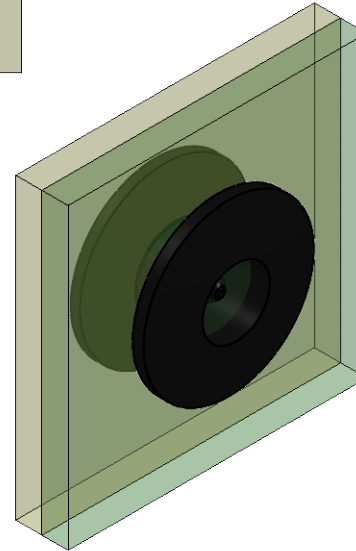
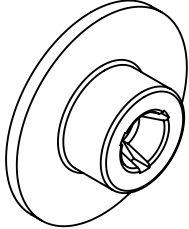
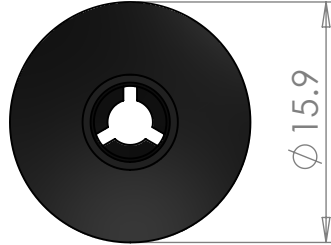
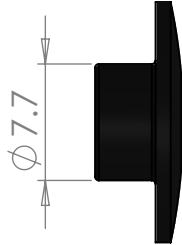

**NOTES:**

COMPONENT IS ROHS COMPLIANT

PART No.	COLOUR	MATL	M/F	HOLE SIZE	PANEL RANGE		HEAD DIA.
					MIN	MAX	
40018-BLK	BLACK	PA66	FEMALE	Ø 8.2	-	-	Ø 15.9
40018-NAT	NATURAL	PA66	FEMALE	Ø 8.2	-	-	Ø 15.9
40018-CLR	CLEAR	PC	FEMALE	Ø 8.2	-	-	Ø 15.9
40019-BLK	BLACK	PA66	MALE	Ø 8.2	4.3	4.8	Ø 15.9
40019-NAT	NATURAL	PA66	MALE	Ø 8.2	4.3	4.8	Ø 15.9
40019-CLR	CLEAR	PC	MALE	Ø 8.2	4.3	4.8	Ø 15.9
40020-BLK	BLACK	PA66	MALE	Ø 8.2	5.6	6.1	Ø 15.9
40020-NAT	NATURAL	PA66	MALE	Ø 8.2	5.6	6.1	Ø 15.9
40020-CLR	CLEAR	PC	MALE	Ø 8.2	5.6	6.1	Ø 15.9
40021-BLK	BLACK	PA66	MALE	Ø 8.2	8.1	8.6	Ø 15.9
40021-NAT	NATURAL	PA66	MALE	Ø 8.2	8.1	8.6	Ø 15.9
40021-CLR	CLEAR	PC	MALE	Ø 8.2	8.1	8.6	Ø 15.9

ISSUE	DATE	SIG	REMARKS
3	16/01/18	BK	DRAWING BROUGHT INTO LINE
2	28/05/13	CJD	DRAWING NO. CHANGED FROM TF12032x, CLEAR PARTS ADDED
1	28/04/06	CJD	SALES DRAWING

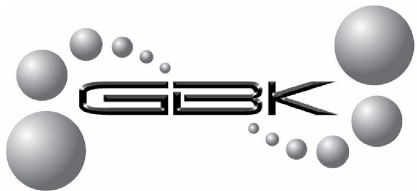

email: info@gbk-uk.com  
web: www.gbk-uk.com

TOLERANCES UNLESS OTHERWISE STATED  
 X 0.50  
 X.X 0.25  
 X.XX 0.10  
 X.XXX 0.05  
 ANGLES 0.25

ALL DIMENSIONS IN MM

THIRD ANGLE PROJECTION



DO NOT SCALE DRAWING  
IF IN DOUBT PLEASE ASK

MATERIAL	SEE TABLE
COLOUR	SEE TABLE
SCALE	2:1 UNLESS SPECIFIED
DRAWN	CJD
DATE	28/05/13
SHEET	1 OF 1

© GBK UK Limited

THESE DRAWINGS AND THE SPECIFICATIONS, AND THE DATA CONTAINED THEREIN ARE THE PROPERTY OF GBK UK LIMITED, ISSUED IN STRICT CONFIDENCE AND SHALL NOT WITHOUT PRIOR WRITTEN PERMISSION OF GBK UK LIMITED BE PRODUCED, COPIED OR USED FOR ANY PURPOSE WHATSOEVER, EXCEPT THE MANUFACTURE OR ARTICLES FOR GBK UK LIMITED

DESCRIPTION	DRAWING No.
SNAP RIVET	40018-21